

Recommended P.C.B Layout
General Tolerance±0.05

Specifications:

Current Rating: 1.0A AC/DC
 Voltage rating: 50V AC/DC
 Temperature range: -25°C to +85°C
 Contact resistance: 30mΩ max.
 Insulation resistance: 100MΩ min.
 Withstand voltage: 500V AC/minute
 Package: tape & reel

Material:

Housing: LCP, UL94V-0, beige
 PIN: phosphor bronze
 Solder tab: brass

Circuits	Dimensions (mm)		
	A	B	C
10	5.00	9.50	8.70
12	6.25	10.75	9.95
14	7.50	12.00	11.20
16	8.75	13.25	12.45
18	10.00	14.50	13.70
20	11.25	15.75	14.95
22	12.50	17.00	16.20
24	13.75	18.25	17.45
26	15.00	19.50	18.70
28	16.25	20.75	19.95
30	17.50	22.00	21.20
32	18.75	23.25	22.45
34	20.00	24.50	23.70
36	21.25	25.75	24.95
38	22.50	27.00	26.20
40	23.75	28.25	27.45

Mates with: 1258W (wire connector)

Part Number Information:

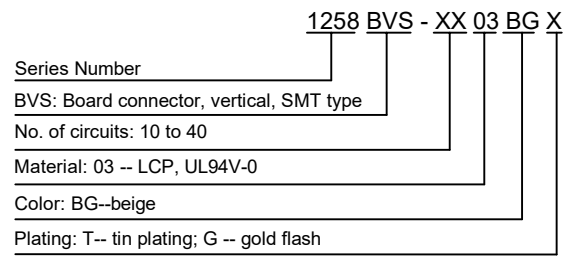

Date	Version	EC No.	Description	DRWN	CH'K	APPR	THIRD ANGLE PROJECTION	Zeakka Electronics				Document No.: ZK-1258BVS		
								APPR	CH'K	DRWN	Date	Title: HEADER, VERTICAL, SMT TYPE, SINGLE ROW, 1.25MM PITCH	Dimensions	Scale
							General Tolerance .X ±0.3 .XX ±0.2 .XXX ±0.1	Kai Lee	Cris Wang	Jun Wei	2020.8.8	mm	1:1	A

Circuits	Dimensions (mm)	
	A	B
10	5.00	9.50
12	6.25	10.75
14	7.50	12.00
16	8.75	13.25
18	10.00	14.50
20	11.25	15.75
22	12.50	17.00
24	13.75	18.25
26	15.00	19.50
28	16.25	20.75
30	17.50	22.00
32	18.75	23.25
34	20.00	24.50
36	21.25	25.75
38	22.50	27.00
40	23.75	28.25

Specifications:

Current Rating: 1.0A AC/DC
Voltage rating: 50V AC/DC
Temperature range: -25°C to +85°C
Contact resistance: 30mΩ max.
Insulation resistance: 100MΩ min.
Withstand voltage: 500V AC/minute

Material:

Housing: nylon 66, UL94V-0, white

Mates with: 1258BVS (header, vertical, SMT type)

Used with: 1258TF-PX (female terminal)

Part Number Information:

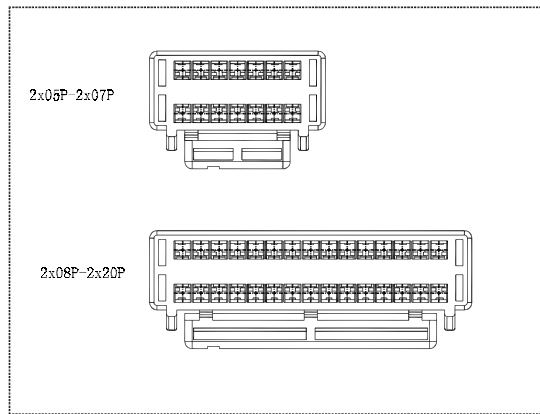
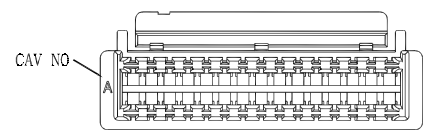
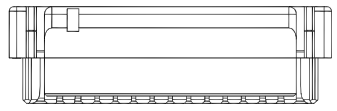
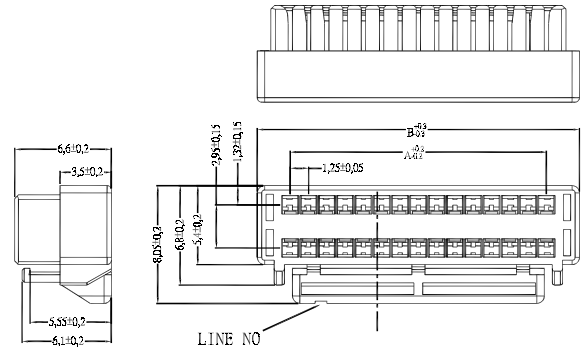
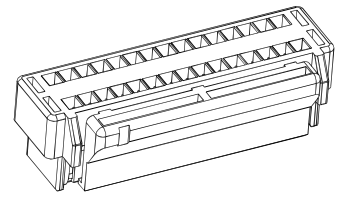
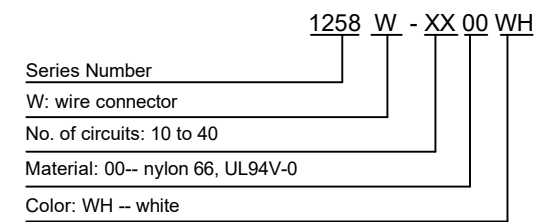

							General Tolerance	Zeakka Electronics				Document No.: ZK-1258W		
							.X ±0.3					Title: HOUSING, FEMALE, CRIMP TYPE, SINGLE ROW, 1.25MM PITCH		
							.XX ±0.2	APPR	CH'K	DRWN	Date	Dimensions	Scale	Version
							.XXX ±0.1	Kai Lee	Cris Wang	Jun Wei	2020.8.8	mm	1:1	A
Date	Version	EC No.	Description	DRWN	CH'K	APPR	THIRD ANGLE PROJECTION							
							☉							

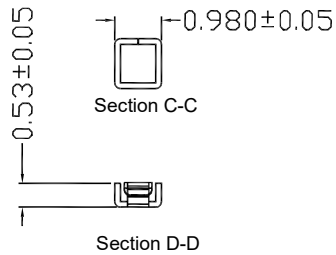
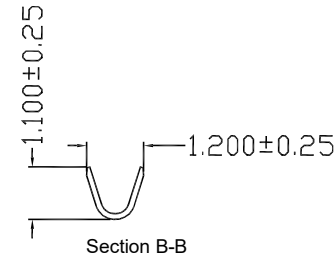
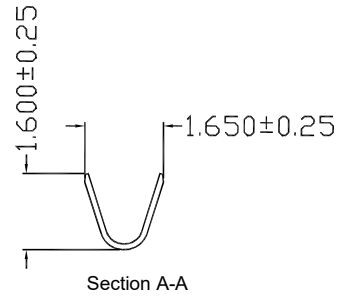
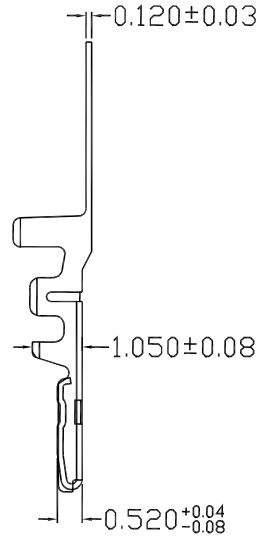
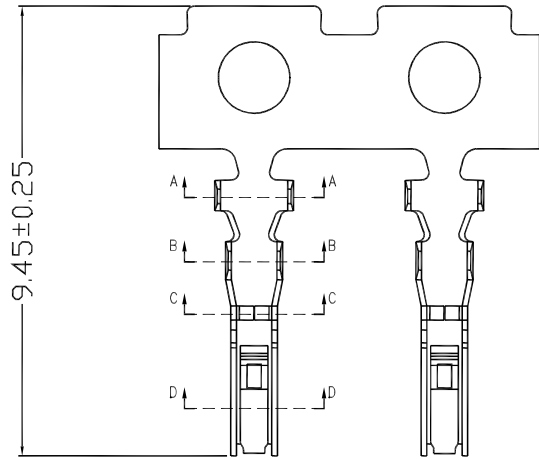

Specifications:

Current Rating: 1.0A AC/DC
 Voltage rating: 50V AC/DC
 Temperature range: -25°C to +85°C
 Contact resistance: 30mΩ max.
 Insulation resistance: 100MΩ min.
 Withstand voltage: 500V AC/minute
 Applicable wire: AWG30 - AWG26
 Insulation OD: max 1.0mm
 Package: reel

Material:

Phosphor bronze

Used with: 1258W (wire connector)

Part Number Information:

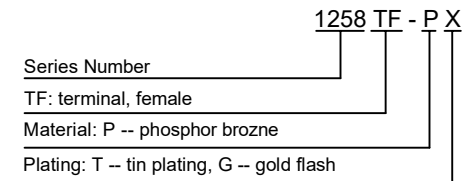

							General Tolerance	Zeakka Electronics				Document No.: ZK-1258T						
							.X ±0.3					Title: TERMINAL, FEMALE, CRIMP TYPE, PHOSPHOR BRONZE, REEL						
							.XX ±0.2					APPR	CH'K	DRWN	Date	Dimensions	Scale	Version
							.XXX ±0.1					Kai Lee	Cris Wang	Jun Wei	2020.8.8	mm	1:1	A
Date	Version	EC No.	Description	DRWN	CH'K	APPR	THIRD ANGLE PROJECTION											