

Specifications:

- Current Rating: 3.0A AC/DC
- Voltage rating: 250V AC/DC
- Temperature range: -25°C to +85°C
- Contact resistance: 10mΩ max.
- Insulation resistance: 1000MΩ min.
- Withstand voltage: 800V AC/minute

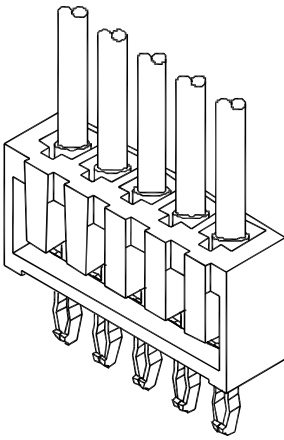

Material:

Housing: nylon 66, UL94V-0, white

Used with: 2507T-PT (terminal)

Part Number Information:

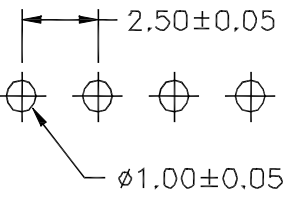
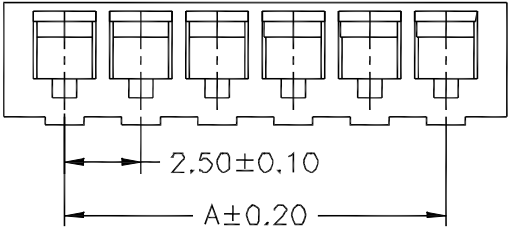
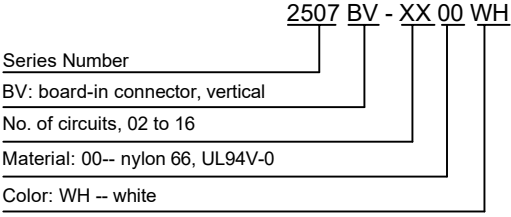

P.C.B LAYOUT

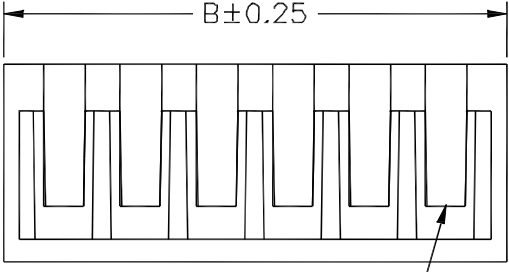

Circuit 1

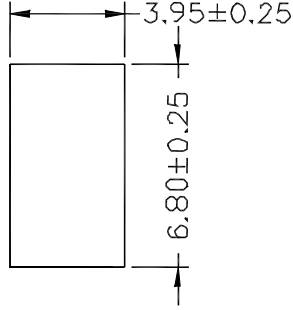

							General Tolerance	<h1>Zeakka Electronics</h1>				Document No.: ZK-2507BV						
							.X ±0.3					Title: HOUSING, BOARD-IN TYPE, SINGLE ROW, 2.5MM PITCH						
							.XX ±0.2					APPR	CH'K	DRWN	Date	Dimensions	Scale	Version
							.XXX ±0.1					Kai Lee	Cris Wang	Jun Wei	2020.8.8	mm	1:1	A
Date	Version	EC No.	Description	DRWN	CH'K	APPR	THIRD ANGLE PROJECTION											

Specifications:

Current Rating: 3.0A AC/DC
 Voltage rating: 250V AC/DC
 Temperature range: -25°C to +85°C
 Contact resistance: 10mΩ max.
 Insulation resistance: 1000MΩ min.
 Withstand voltage: 500V AC/minute
 Applicable wire: AWG28 - AWG22
 Insulation OD: max 1.70mm

Material:

Phosphor bronze

Used with: 2507BV (board-in connector, vertical)

Part Number Information:

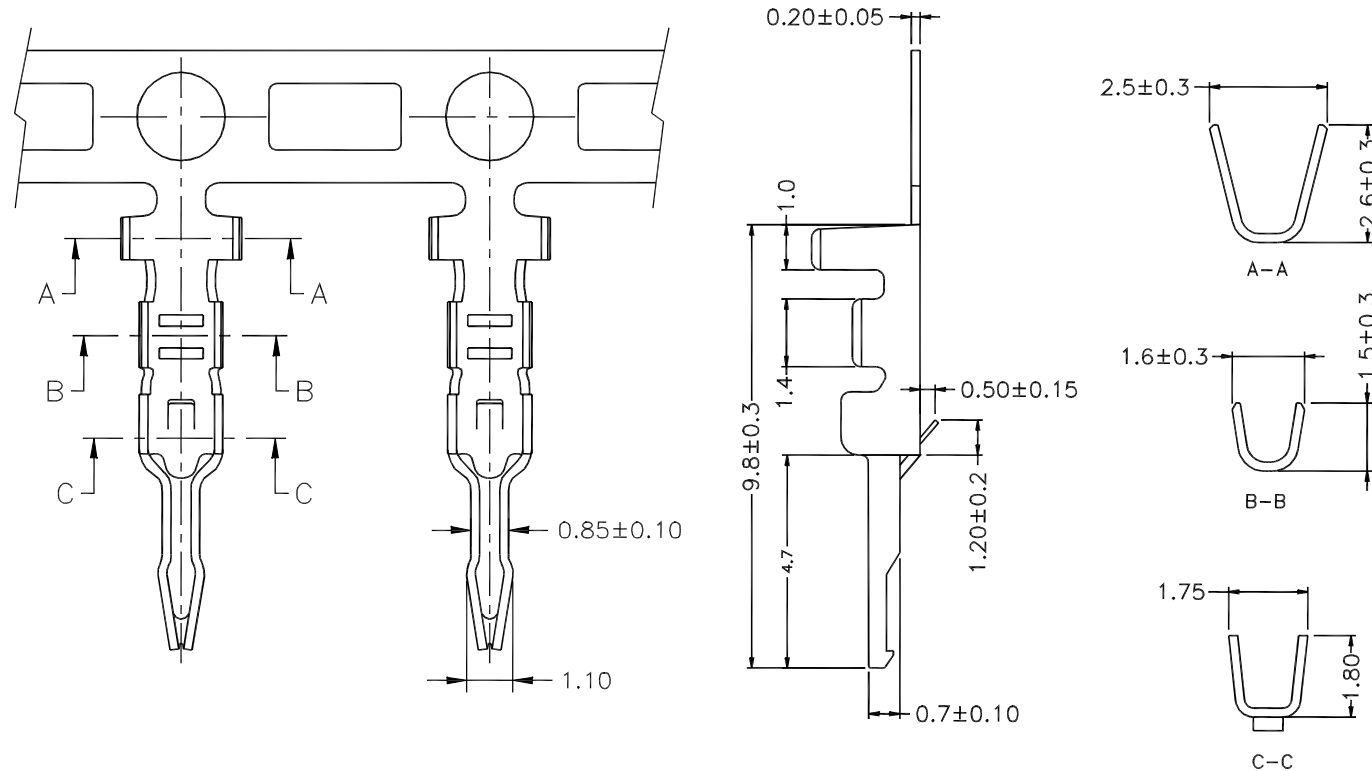
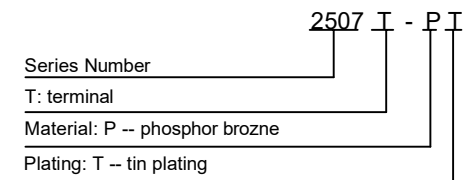

							General Tolerance	Zeakka Electronics				Document No.: ZK-2507T						
							.X ±0.3					Title: TERMINAL, BOARD-IN TYPE, PHOSPHOR BRONZE, TIN, REEL						
							.XX ±0.2					APPR	CH'K	DRWN	Date	Dimensions	Scale	Version
							.XXX ±0.1					Kai Lee	Cris Wang	Jun Wei	2020.8.8	mm	1:1	A
Date	Version	EC No.	Description	DRWN	CH'K	APPR	THIRD ANGLE PROJECTION											